

SOCKET WELD PIPE ELBOW FLANGES

3000 SERIES SQUARE BOLT PATTERN

FLANGE SIZE	PIPE SIZE	PART NUMBER	A	B	C	D	E	F	G	H	K	MOUNTING KIT®			WT
									J			PART NO.	SCREW SIZE	O-RING	
1/2	1/2	1411-08-08	2.75	2.25	1.50	.719	1.438	.50	.41	.50	.860	MK 532	3/8-16 x 2 1/4	216	2.3
		1412-08-08							3/8-16			-----	---		
3/4	3/4	1411-12-12	2.75	2.25	1.50	.719	1.438	.75	.41	.50	1.070	MK 532	3/8-16 x 2 1/4	216	2.0
		1412-12-12							3/8-16			-----	---		
1	1	1411-16-16	3.50	3.00	2.00	1.000	2.000	1.00	.53	.50	1.335	MK 533	1/2-13 x 2 3/4	222	4.8
		1412-16-16							1/2-13			-----	---		
1 1/4	1 1/4	1411-20-20	3.50	3.00	2.25	1.000	2.000	1.25	.53	.50	1.680	MK 534	1/2-13 x 3	222	5.1
		1412-20-20							1/2-13			-----	---		
1 1/2	1 1/2	1411-24-24	4.62	4.00	3.00	1.375	2.750	1.50	.66	.62	1.920	MK 535	5/8-11 x 4	228	12.1
		1412-24-24							5/8-11			-----	---		
2	2	1411-32-32	4.62	4.00	3.50	1.375	2.750	1.94	.66	.62	2.411	MK 1598	5/8-11 x 4 1/2	228	13.1
		1412-32-32							5/8-11			-----	---		
2 1/2	2 1/2	1411-40-40	6.25	5.50	4.00	1.875	3.750	2.44	.94	.75	2.911	MK 536	7/8-9 x 5 1/2	236	28.6
		1412-40-40							7/8-9			-----	---		
3	3	1411-48-48	6.25	5.50	4.50	1.875	3.750	2.88	.94	.75	3.540	MK 537	7/8-9 x 6	236	31.9
		1412-48-48							7/8-9			-----	---		
3 1/2	3 1/2	1411-56-56	7.00	6.00	5.50	2.125	4.250	3.38	.94	.75	4.045	MK 3528	7/8-9 x 7	240	47.2
		1412-56-56							7/8-9			-----	---		
4	4	1411-64-64	8.00	7.00	6.00	2.500	5.000	3.88	1.06	1.00	4.550	MK 2573	1-8 x 7 1/2	347	66.8
		1412-64-64							1-8			-----	---		
5	5	1411-80-80	9.00	8.00	7.00	3.000	6.000	4.81	1.06	1.00	5.635	MK 3522	1-8 x 8 1/2	355	97.0
		1412-80-80							1-8			-----	---		

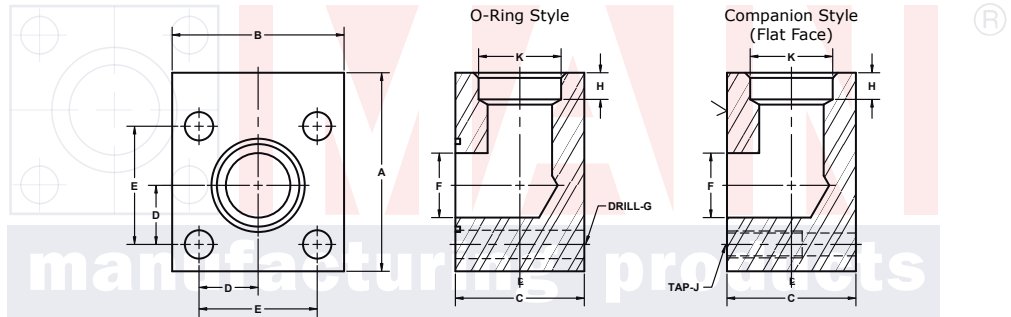
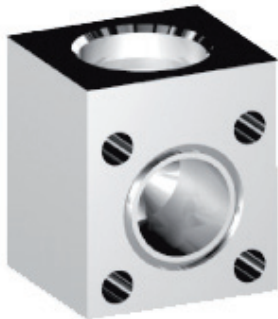

MATERIAL: **Low Carbon Steel** Model 1411 / 1413 Model 1412 / 1414

3181 TRI-PARK DR. GRAND BLANC, MI 48439 800-521-7918 810-953-1380 FAX 810-953-1385 INFO@MAINMFG.COM

6000 SERIES SQUARE BOLT PATTERN

FLANGE SIZE	PIPE SIZE	PART NUMBER	A	B	C	D	E	F	G	H	K	MOUNTING KIT®			WT
									J			PART NO.	SCREW SIZE	O-RING	
1/2	1/2	1413-08-08	2.75	2.25	1.50	.719	1.438	.50	.41	.50	.860	MK 5515	3/8-16 x 2 1/4	210	2.2
		1414-08-08							3/8-16			-----	---		
3/4	3/4	1413-12-12	3.00	2.50	1.75	.875	1.750	.62	.41	.50	1.070	MK 542	3/8-16 x 2 1/2	214	3.2
		1414-12-12							3/8-16			-----	---		
1	1	1413-16-16	3.50	3.00	2.25	1.000	2.000	.81	.53	.50	1.335	MK 5516	1/2-13 x 2 3/4	219	5.5
		1414-16-16							1/2-13			-----	---		
1 1/4	1 1/4	1413-20-20	4.62	4.00	3.00	1.375	2.750	1.16	.66	.50	1.680	MK 5517	5/8-11 x 4	222	13.1
		1414-20-20							5/8-11			-----	---		
1 1/2	1 1/4	1413-24-20	4.62	4.00	3.00	1.375	2.750	1.34	.66	.50	1.680	MK 553	5/8-11 x 4	225	13.0
		1414-24-20							5/8-11			-----	---		
1 1/2	1 1/2	1413-24-24	4.62	4.00	3.00	1.375	2.750	1.34	.66	.62	1.920	MK 553	5/8-11 x 4	225	12.5
		1414-24-24							5/8-11			-----	---		
1 1/2	2	1413-24-32	4.62	4.00	3.50	1.375	2.750	1.34	.66	.62	2.411	MK 1587	5/8-11 x 4 1/2	225	14.6
		1414-24-32							5/8-11			-----	---		
2	1 1/2	1413-32-24	5.50	5.00	4.00	1.750	3.500	1.69	.78	.62	1.920	MK 4580	3/4-10 x 5 1/2	228	26.5
		1414-32-24							3/4-10			-----	---		
2	2	1413-32-32	5.50	5.00	4.00	1.750	3.500	1.69	.78	.62	2.411	MK 4580	3/4-10 x 5 1/2	228	25.5
		1414-32-32							3/4-10			-----	---		
2 1/2	2 1/2	1413-40-40	6.25	5.50	4.50	1.875	3.750	2.12	.94	.75	2.911	MK 2557	7/8-9 x 6	232	34.0
		1414-40-40							7/8-9			-----	---		
3	3	1413-48-48	8.00	7.00	5.00	2.375	4.750	2.62	1.06	.75	3.540	MK 5518	1-8 x 7	236	64.0
		1414-48-48							1-8			-----	---		

① Order Separately