

4 BOLT SQUARE, BUTT WELD IN-LINE FLANGES

3000 SERIES For Schedule 80 Pipe ®

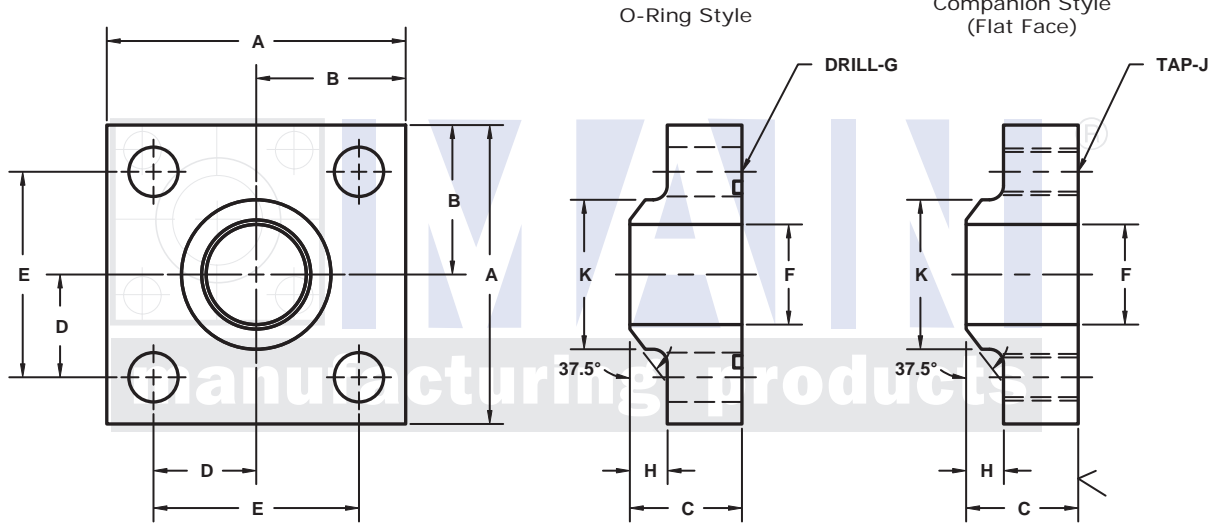
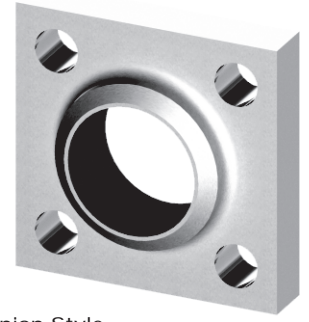
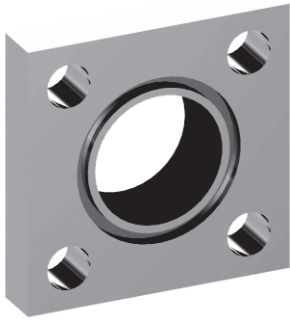

Model 1399

Model 1400

3181 TRI-PARK DR. GRAND BLANC, MI 48439 800-521-7918 810-953-1380 FAX 810-953-1385 INFO@MAINMFG.COM

FLANGE SIZE	PIPE SIZE	PART NUMBER	A	B	C	D	E	F	G		H	K	MOUNTING KIT®			WT
									J				PART NO.	BOLT SIZE	O-RING	
1/2	1/2	1399-08-08	2.25	1.12	1.25	.719	1.438	.53	.41	.38	.88		MK 528	3/8-16 x 1 3/4	216	1.0
		3/8-16							-----				---			
3/4	3/4	1399-12-12	2.25	1.12	1.25	.719	1.438	.75	.41	.38	1.12		MK 528	3/8-16 x 1 3/4	216	1.1
		3/8-16							-----				---			
1	1	1399-16-16	3.00	1.50	1.25	1.000	2.000	.94	.53	.38	1.38		MK 529	1/2-13 x 1 3/4	222	1.6
		1/2-13							-----				---			
1 1/4	1 1/4	1399-20-20	3.00	1.50	1.25	1.000	2.000	1.25	.53	.38	1.75		MK 529	1/2-13 x 1 3/4	222	1.5
		1/2-13							-----				---			
1 1/2	1 1/4	1399-24-20	4.00	2.00	1.50	1.375	2.750	1.25	.66	.50	1.75		MK 581	5/8-11 x 2	228	3.3
		5/8-11							-----				---			
1 1/2	1 1/2	1399-24-24	4.00	2.00	1.50	1.375	2.750	1.50	.66	.50	2.00		MK 581	5/8-11 x 2	228	3.2
		5/8-11							-----				---			
2	2	1399-32-32	4.00	2.00	1.50	1.375	2.750	1.94	.66	.50	2.50		MK 581	5/8-11 x 2	228	3.1
		5/8-11							-----				---			
2 1/2	2	1399-40-32	5.50	2.75	1.75	1.875	3.750	1.94	.94	.50	2.50		MK 1519	7/8-9 x 2 1/2	236	7.5
		7/8-9							-----				---			
2 1/2	2 1/2	1399-40-40	5.50	2.75	1.75	1.875	3.750	2.32	.94	.50	3.00		MK 1519	7/8-9 x 2 1/2	236	7.3
		7/8-9							-----				---			
3	3	1399-48-48	5.50	2.75	1.75	1.875	3.750	2.90	.94	.50	3.50		MK 1519	7/8-9 x 2 1/2	236	6.7
		7/8-9							-----				---			
3 1/2	3 1/2	1399-56-56	6.00	3.00	1.75	2.125	4.250	3.36	.94	.50	4.00		MK 1577	7/8-9 x 2 1/2	240	9.7
		7/8-9							-----				---			
4	4	1399-64-64	7.00	3.50	2.00	2.500	5.000	3.83	1.06	.50	4.50		MK 1578	1-8 x 3	347	15.5
		1-8							-----				---			
5	5	1399-80-80	8.00	4.00	2.50	3.000	6.000	4.81	1.06	.50	5.62		MK 1579	1-8 x 3 1/2	355	25.2
		1-8							-----				---			
6	6	1399-96-96	10.00	5.00	2.50	3.500	7.000	5.75	1.31	.50	6.75		MK 5533	1 1/4-7 x 4	362	40.4
		1 1/4-7							-----				---			

① Order Separately ② Other Schedules Available Include: Schedules 40, 160 and XXS